

— GH

O

ST



GH
GH





Con Ghost Project siamo andati all'essenza. Alla purezza della luce e di ciò che la incornicia e la accompagna. Per noi è il successo che corona i nostri primi 10 anni.

With Ghost we wanted to go further, until reaching the essence of light, the purity of forms, the integrity of reflection. For us it is the success which marks our first ten years.

Alexander Caruso and Monica De Conti
Founders of Vanità & Casa

7	Intro
10	Exclusive advantages
14	Ghost Light
20	Handy System Massimo Farinatti
30	Handy Mirror Massimo Farinatti
32	Magnetica System Massimo Farinatti
44	XO Mirror Massimo Farinatti
50	Ghost World
54	Pollux-GH Adolini + Simonini
60	Castore-GH Adolini + Simonini
64	Fenice R&D Vanità & Casa
70	Avior R&D Vanità & Casa
74	Starburst R&D Vanità & Casa
78	Oceano Massimo Farinatti R&D Vanità & Casa
82	Astro R&D Vanità & Casa
86	Titan Rounded Adolini + Simonini
90	Tristar R&D Vanità & Casa
94	Zenit R&D Vanità & Casa
98	Technical data
102	Product description





Costruita sulle esigenze di una realtà in costante crescita, Vanità & Casa è attualmente presente in oltre 25 paesi nel mondo. Da Aviano, sede dello stabilimento, seguiamo ogni aspetto dei nostri specchi, specchi contenitori e mobiletti da bagno, dalla progettazione alla commercializzazione, dal controllo qualità alla logistica.

Built on the needs of a constantly growing reality, Vanità & Casa is currently present in over 25 countries around the world. From our Aviano headquarters, we follow every aspect of our mirrors, mirror cabinets and furniture units, from design to marketing, from quality control to logistics.

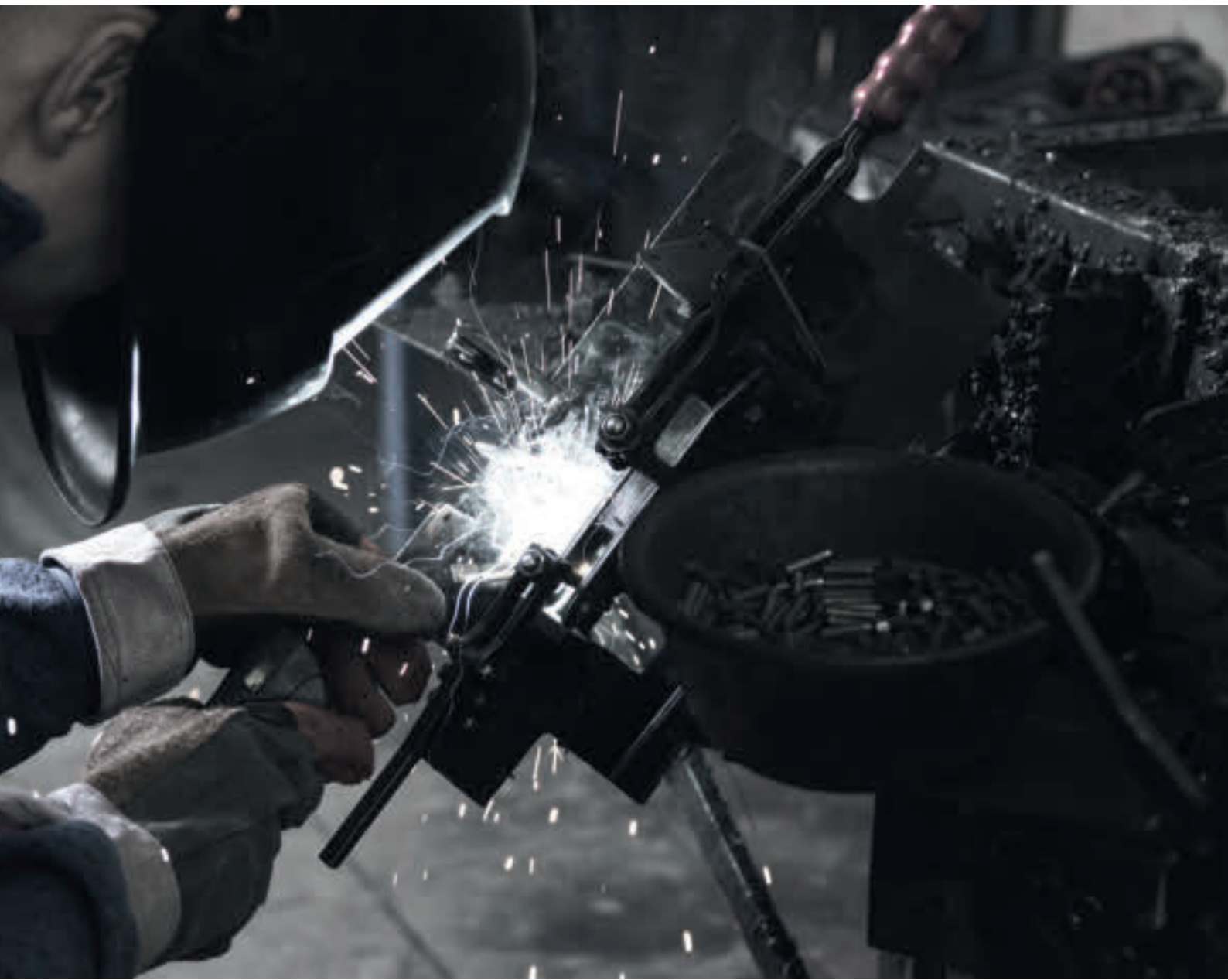

Vanità & Casa nasce nel 2011 dall'esperienza maturata da Alexander Caruso nel settore dell'arredobagno con l'obiettivo di offrire prodotti unici, perfetta sintesi tra innovazione e design.

L'estrema attenzione alla sicurezza, qualità, funzionalità e sostenibilità si traducono per noi in un controllo diretto su ogni passaggio del ciclo produttivo, dall'ideazione all'imballo finale.

Gli specchi Vanità & Casa sono progettati in Italia, nella nostra sede di Aviano, in provincia di Pordenone; specchi e componenti vengono fabbricati e assemblati in Cina, con partner attentamente selezionati, in grado di condividere con noi la passione per l'eccellenza e di garantire capacità produttiva e puntualità, impiego di una forza-lavoro adulta e qualificata, rispetto di rigorose norme di salute e sicurezza per il personale.

Sempre attenti all'evoluzione degli ambienti e degli stili di vita, portiamo avanti una costante attività di ricerca e sviluppo che ci consente di essere sempre in linea con i più elevati standard e di utilizzare le più avanzate tecnologie al servizio della persona e delle sue esigenze.

Vanità & Casa was founded in 2011 from the experience gained by Alexander Caruso in the sanitary-ware market with the aim of offering unique products, with a perfect synthesis between innovation and design.

The extreme attention to safety, quality, functionality and sustainability is translated for us into direct control over each step of the production cycle, from the initial design to the final packaging.

Vanità & Casa mirrors are designed and engineered in Italy, in our headquarters in Aviano in the province of Pordenone while the mirrors and components are manufactured and assembled in China. We have carefully selected our partners who share with us the passion for excellence and guarantee quality products, capacity and punctuality. Moreover, our production facilities use an adult and qualified workforce in compliance with strict health and safety rules for factory workers.

Always attentive to the evolution of environment and lifestyles, we carry out constant research and development which permit us to always be in line with the highest standards and to use the most advanced technologies at the service of the users and their needs.

Exclusive advantages



Ghost Light Technology

Lo specchio in tutta la sua purezza. La presenza della luce è invisibile, comparirà solo quando lo vorrai e scomparirà con un semplice comando: con Ghost superiamo i limiti della tecnologia per andare all'essenza del riflesso.

The mirror in all its purity. The presence of light is invisible, it will appear only when you want it and disappear with a simple command: with Ghost Mirror we go beyond the limits of technology to go to the essence of reflection.



Carica wireless Wireless charger

Ricaricare il tuo dispositivo mobile è semplice. Non servono cavi: basta appoggiarlo sulla mensola del tuo specchio e la nostra tecnologia a induzione magnetica lo alimenterà.

Charging your mobile device is simple. No cables required - just place your phone or pods on your mirror shelf and our magnetic induction technology will charge it.



Sicurezza Safety

Tutti i nostri prodotti sono progettati per garantire la massima sicurezza: spessore specchio 5 mm, incollaggio al telaio a massima tenuta, protezione IP44, retro-pellicola di sicurezza che, in caso di rottura, impedisce allo specchio di sbriciolarsi, evitando la formazione di schegge.

All our products are designed to guarantee maximum safety: 5 mm mirror thickness, high adhesive properties secure the frame to the mirror back, IP44 protection, safety film backing which, in case of breakage, prevents the mirror from crumbling, avoiding the formation of slivers.



Certificazioni Certifications

Ogni prodotto è a Marchio CE (Fascicolo Tecnico e Dichiarazione di Conformità adeguati alle Direttive LVD e EMC) e testato come apparecchio separato. Tutti i prodotti distribuiti in Australia e Nuova Zelanda e in Giappone sono certificati rispettivamente SAA e PSE.

Each product is CE marked (Technical File and Declaration of Conformity complete with LVD and EMC Directives). Each mirror model/size is tested as a separate appliance. All products distributed in Australia and New Zealand and Japan are SAA and PSE certified respectively.



Prodotto ecostenibile
Eco-conscious product

L'imballaggio dei prodotti è completamente "plastic-free", la struttura in alluminio che circonda lo specchio e il Plexiglas impiegato per diffondere la luce LED sono totalmente riciclabili.

The product packaging is completely plastic free; both the aluminum frame and the Plexiglas surrounding structure used to diffuse the LED light are both totally recyclable.



Calibrazione luce calda/fredda
Warm/cold light calibration

Scegli il mix perfetto per te. A seconda dell'illuminazione del tuo ambiente potrai variare e calibrare la tonalità della luce in base alla pressione del tuo dito sul sensore touch.

Choose the perfect mix. Depending on the lighting in your environment, you can vary and calibrate the tone of the light based by a long press of the touch sensor.



Antiappannamento
Defogger

Inserita all'interno dello specchio un'anima riscaldante impedisce al vapore presente nella stanza da bagno di posarsi sulla superficie specchiante. Per un'immagine sempre nitida.

Position on the mirror back, a heating pad prevents the steam present in the bathroom from settling on the mirror surface. For an always sharp image.



Facile da appendere
Easy to hang

Con il nostro sistema "X Hanging", che permette il posizionamento sia orizzontale che verticale di alcuni specchi, l'installazione è rapida e facilitata dalla dima di foratura.

With our "X Hanging" system, which allows both horizontal and vertical positioning of some mirrors, installation is quick and easy and facilitated by a paper template.



LED a bassi consumi
*Low power consumption
LEDs*

Sempre attenti alle più avanzate tecnologie illuminotecniche, utilizziamo lampade LED di ultima generazione che uniscono altissime prestazioni a fronte di bassissimi consumi energetici.

Always attentive to the most advanced lighting technologies, we use the latest generation LED lamps that combine very high performance with very low energy consumption.



Sensore touch
Touch sensor

Ti basta un semplice tocco, anche al buio, per accendere o spegnere il tuo specchio. E su alcuni modelli troverai l'interruttore touch dedicato alla funzione anti-appannamento.

Only a simple touch, even in the dark, to turn your mirror on or off. And on some models you will also find a dedicated touch switch for the defogger function



Sensore a infrarossi
Infrared sensor

Riduce lo spreco energetico: il sensore rileva il movimento e accende la luce solo quando sei presente. Evita il contatto fisico con l'interruttore: una funzionalità utile in ambienti pubblici o dove è necessario adottare precauzioni igieniche specifiche.

Reduces energy waste: the sensor detects movement and turns on the light only when you are present. The sensor can be activated without physical contact with the switch: a useful feature in public environments or where it is necessary to take specific hygiene precautions.



Mensola
Shelf

Lo specchio con mensola è un'idea di design molto pratica. La mensola è semplicemente una sorta di naturale estensione dello specchio ed è profonda abbastanza per appoggiare accessori per il make-up e la cura quotidiana.

The mirror with shelf is a very practical design idea. The shelf is merely a sort of natural extension of the mirror and deep enough to hold make-up products or daily care accessories.



Ghost Light

la potenza della tecnica crea la magia

the power of technology creates magic

Con Ghost la potenza della
tecnica crea la magia.
Basta un semplice gesto
e la luce prende vita,
a illuminare la tua immagine.
Un tocco e scompare.
Niente tracce in trasparenza,
niente ombre, nulla resta a
intaccare la purezza delle
superfici.

*With Ghost the power of
technology creates magic.
Just a simple gesture and the
Ghost light comes to life, to
illuminate your image. Another
gesture and the illumination
disappears.... no traces in
transparency, no shadows,
nothing remains to affect the
purity of reflection.*



\ 1
Inquadra il QR-Code
\ 2
Scarica la App
\ 3
Apri ARIA e inquadra le foto
con il simbolo 

\ 1
Scan the QR-Code
\ 2
Download the ARIA App
\ 3
*Open the ARIA App and frame the photos
with the Aria symbol to start the video *



\ Inquadra questa immagine con la telecamera dello smartphone per far partire il video \ Goditi l'esperienza della realtà aumentata

\ Frame this image with the camera of your smartphone to start the video \ Enjoy the augmented reality experience

Ghost è un progetto nel quale abbiamo fermamente creduto. Rendere la fonte luminosa completamente invisibile. Creare una tecnologia nuova per i nostri specchi e specchi contenitori, applicabile sia dietro l'argentatura dello specchio che dietro le cornici nere.

La solida competenza tecnica della nostra squadra e la capacità di selezionare i materiali più innovativi ci hanno permesso di raggiungere questo obiettivo.

Ghost è un brevetto d'invenzione di Vanità & Casa

Ghost is a project in which we firmly believed in.

Make the light source completely invisible.

Creating a new technology for our mirrors and mirror cabinets both behind the silvering of the mirror and behind the black frames.

The solid technical competence of our technical team and the ability to select the most innovative materials permitted us to reach this goal.

Ghost is a Vanità & Casa invention patent



\ Inquadra questa immagine con la telecamera dello smartphone per far partire il video \ Goditi l'esperienza della realtà aumentata

\ Frame this image with the camera of your smartphone to start the video \ Enjoy the augmented reality experience

H

A

N

D

Y







HANDY SYSTEM
Massimo Farinatti

Handy System ripercorre tracce del passato nel segno di una continuità rivisitata alla luce dell'oggi. Un elemento senza soluzione di continuità racchiude e sostiene il cuore della consolle. Ai due lati del lavabo, l'eco dei manici di antichi mastelli diventa sostegno per salviette e asciugamani. Il telaio tubolare segna la continuità con lo specchio, a incorniciare il perimetro illuminato e a sorreggere la mensola portaoggetti

*Handy System retraces the past in the sign of continuity; revisited in the light of today.
A seamless element encloses and supports the heart of the console.
On both sides of the sink, the echo of the handles of ancient basins become towel bars.
The tubular frame marks the continuity with the mirror, to frame the illuminated perimeter and to support the shelf*













HANDY MIRROR
Massimo Farinatti

specchio con mensola
shelf mirror





M

A

G

N

E

T

I

C

A



Magnetica System è l'essenzialità cui nulla manca. Linee rette che trovano continuità e si traducono in funzionalità in una barra di sistema, nella quale si inseriscono mensole, accessori e ganci porta-asciugamani. Forme pure, squadrate, affiancate e sottolineate dalla rotondità dello specchio ingranditore

Magnetica System is essentiality where nothing is missing. Straight lines which find continuity and provide functionality with an accessory bar, in which, shelves, accessories and towel hooks are found. Pure, squared shapes, placed side by side and highlighted by the roundness of the magnifying mirror

















Nulla è lasciato al caso, ogni
consolle dispone di tre serie
di supporti per personalizzare
l'altezza del lavabo

*Nothing is left to chance, each
console comes with three sets of
basin supports to customize the
height of the washbasin*





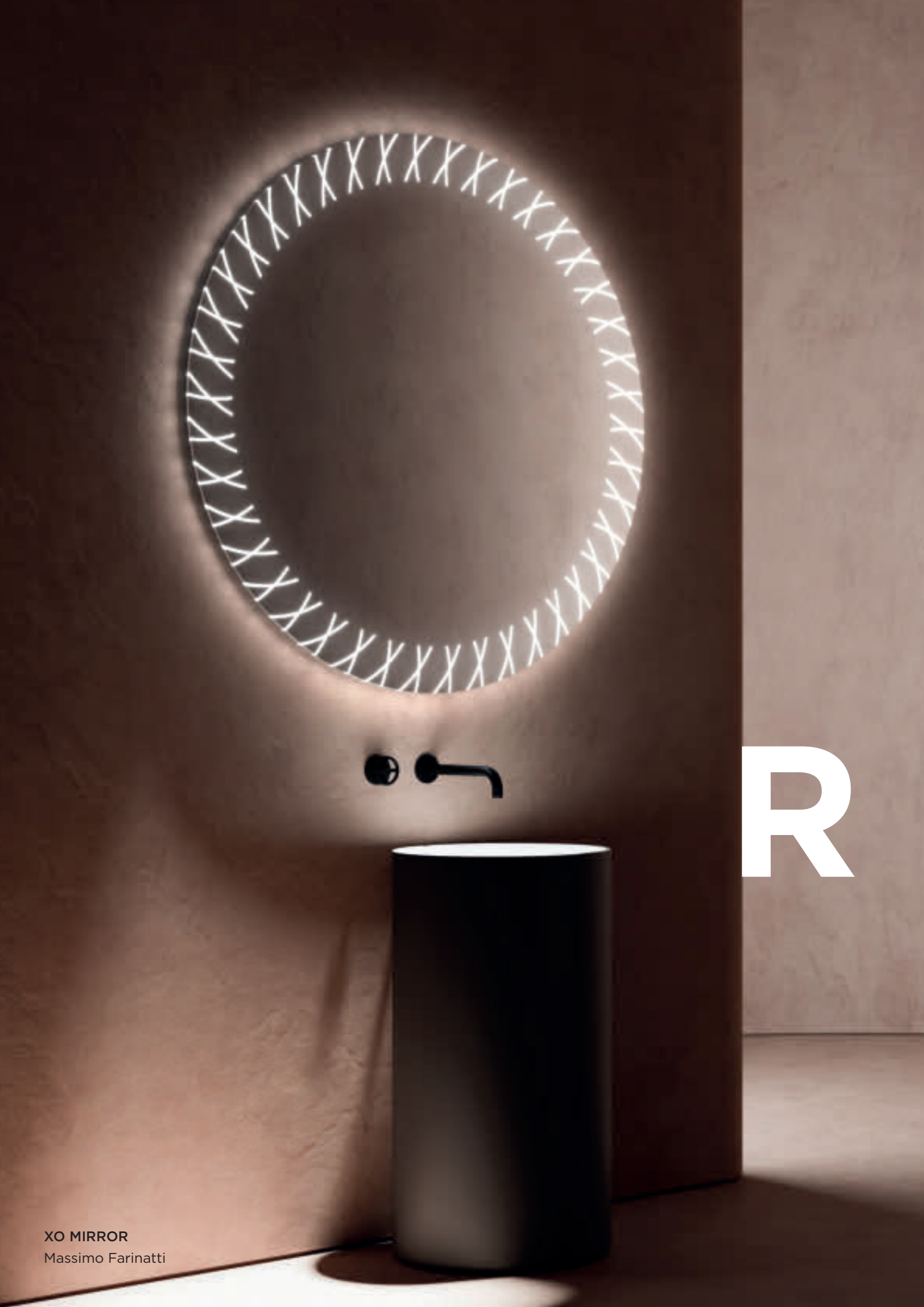

XO MIRROR
Massimo Farinatti

X

O

M

I

R

O

R

La luce esplode in un decoro che
arreda o svanisce discretamente,
grazie alla tecnologia Ghost.
XO si adatta a qualunque ambiente

*The light bursts into a glowing
decoration which appears or
fades discretely, thanks to Ghost
technology.
XO adapts to any environment*



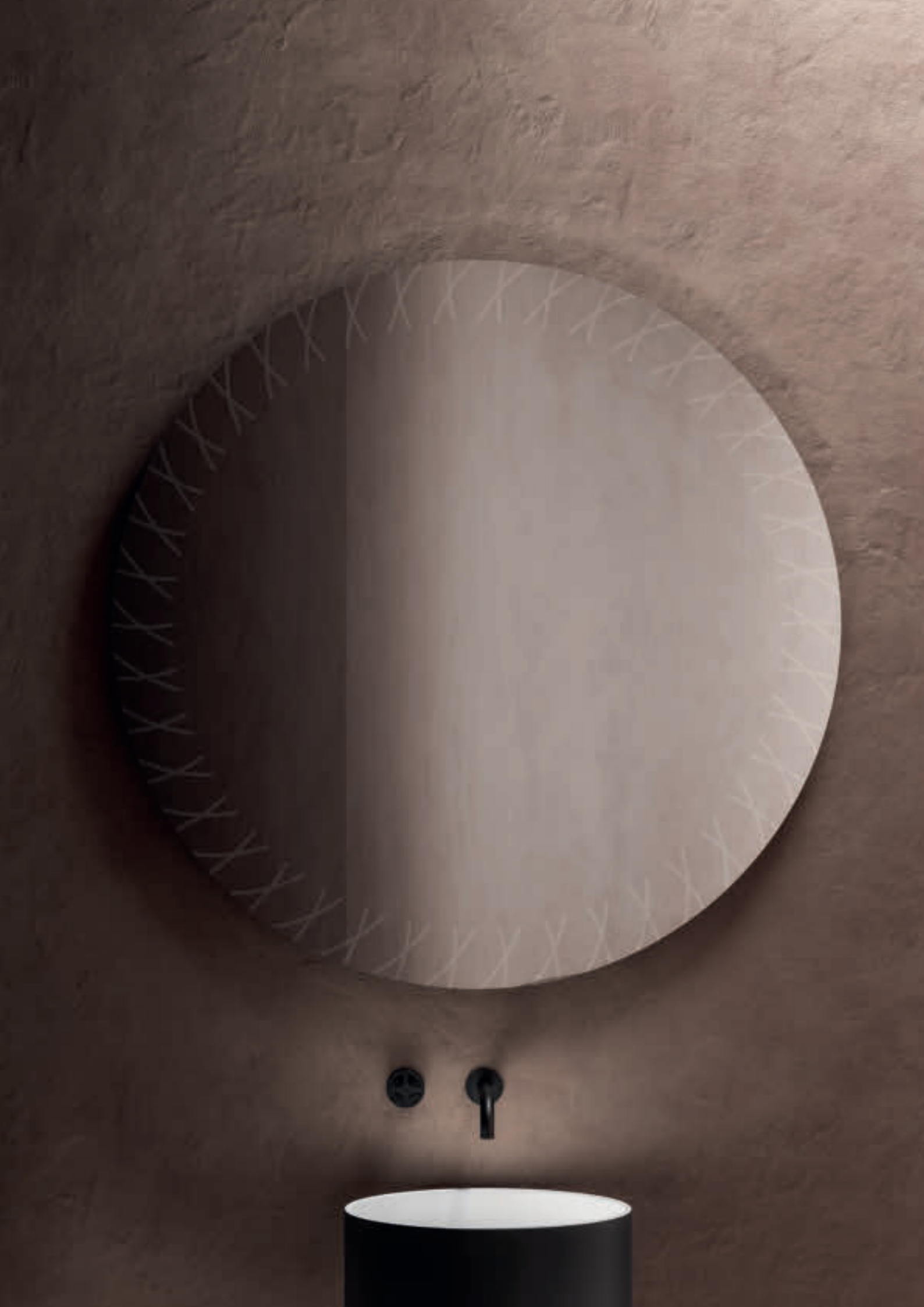





GH O S
W O
L D



R
T



Nel mondo Ghost alcuni specchi della collezione Vanità & Casa sono stati reinterpretati attraverso l'esame del concetto di "fantasma" come figura evanescente che svanisce poco a poco, cosa illusoria o apparizione. Riflessioni che hanno portato alla creazione di una fonte luminosa nello specchio o nel profilo nero, che appare con l'accensione, per poi svanire nuovamente con lo spegnimento nell'intento di arredare usando tecnologia e emozione. Alla componente scenica si abbina infatti quella tecnologica che permette di utilizzare tutta la superficie riflettente dello specchio fino a che la fonte luminosa rimane invisibile

In the Ghost world, some mirrors from the Vanità & Casa collection have been reinterpreted through the examination of the concept of "ghost" as an evanescent figure that vanishes little by little, an illusionary thing or an apparition. Reflections that led to the creation of a light source in the mirror or in the black profile, which appears when turned on and then vanishes again when turned off in order to furnish using technology and emotion. In fact, the stage component is combined with this technology which also allows the use of the entire reflecting surface of the mirror as long as the light source remains invisible



POLLUX GH
Adolini + Simonini



L'ambiente domestico si arricchisce di una luce magica, dalle nuove possibilità, mentre gli oggetti si raccolgono su una comoda mensola

The home environment is enriched with a magical light, with new possibilities, while the objects are gathered on a comfortable shelf



POLLUX GH
Adolini + Simonini

specchio con mensola
shelf mirror







POLLUX GH
Adolini + Simonini

specchio con mensola
shelf mirror







Il rigore di un profilo metallico per esprimere i diversi gradi emotivi della luce. Con un tocco la luce si diffonde nell'ambiente. Un altro tocco e la luce diretta scompare, per definire ed esaltare ogni dettaglio della tua immagine

The rigor of a metal profile to express the different emotional degrees of light. With a touch, the light diffuses into the environment. Another touch and the direct light disappears, to define and enhance every detail of your image



CASTORE GH
Adolini + Simonini

specchio con mensola
shelf mirror



FENICE
R&D Vanità & Casa

specchio con mensola
shelf mirror

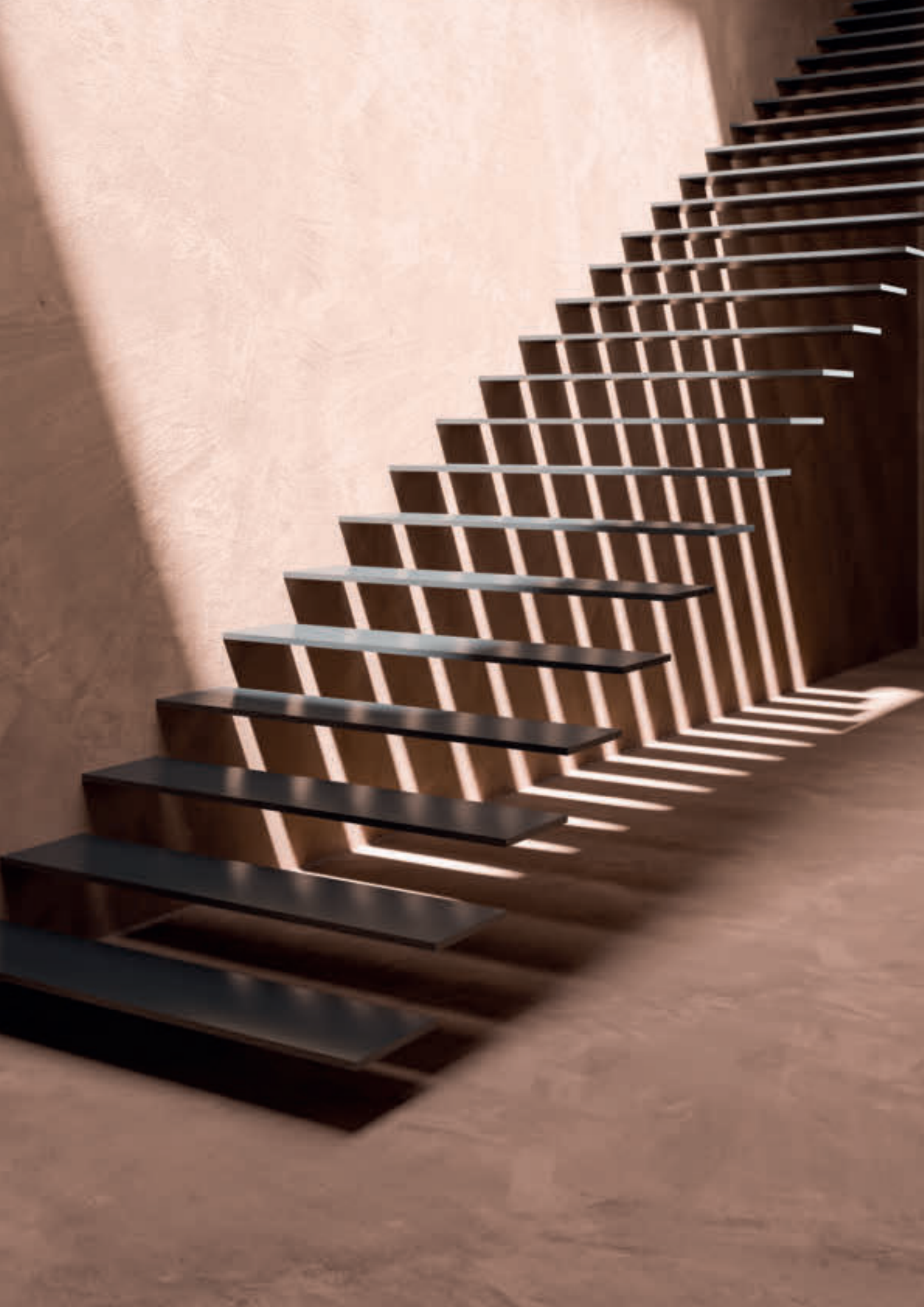

L'essenzialità di una mensola sottile, una cornice che magicamente s'illumina, utili funzionalità come antiappannamento e il caricabatteria wireless per il tuo smartphone

The essentiality of a thin shelf, a frame that magically lights up, useful features such as defogger and a wireless charger for your smartphone

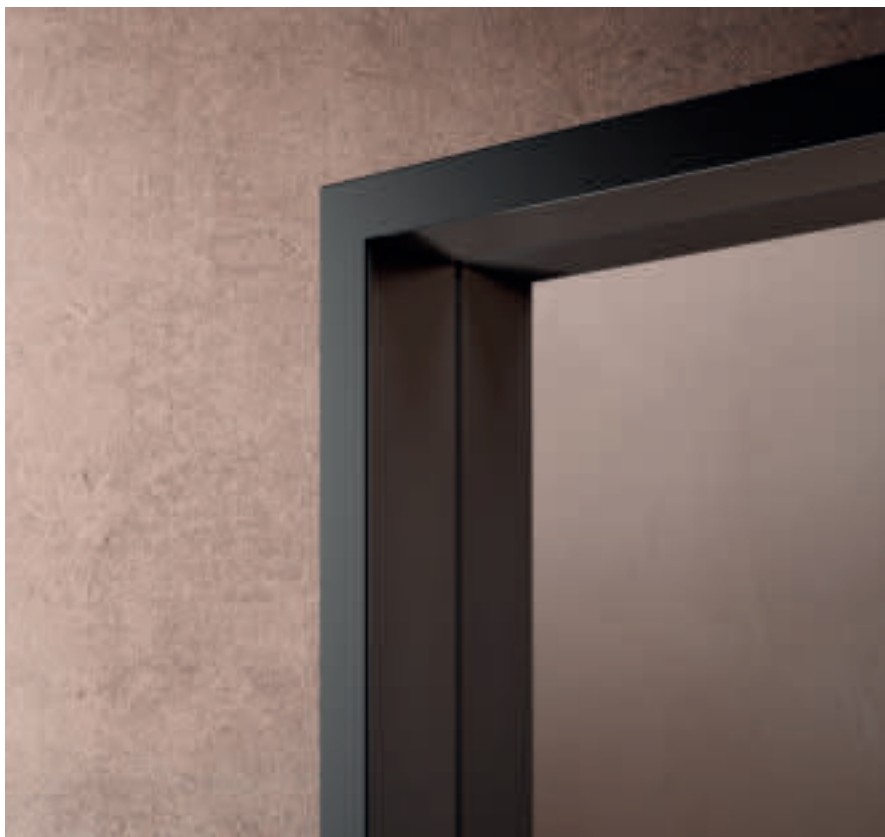







FENICE
R&D Vanità & Casa

specchio con mensola
shelf mirror







Ti basta sfiorare il sensore a infrarossi ed ecco, la tua immagine incorniciata ed esaltata dalla luce inattesa, come in un quadro

Just a wave in proximity of the infrared sensor and behold, your image framed and enhanced by the unexpected light, as in a painting









Un elemento discreto per un bagno essenziale, dove la luce si diffonde grazie alla cornice in Plexiglas

A discreet element for an essential bathroom, where the light diffuses thanks to the Plexiglas frame



OCEANO
Massimo Farinatti
R&D Vanità & Casa



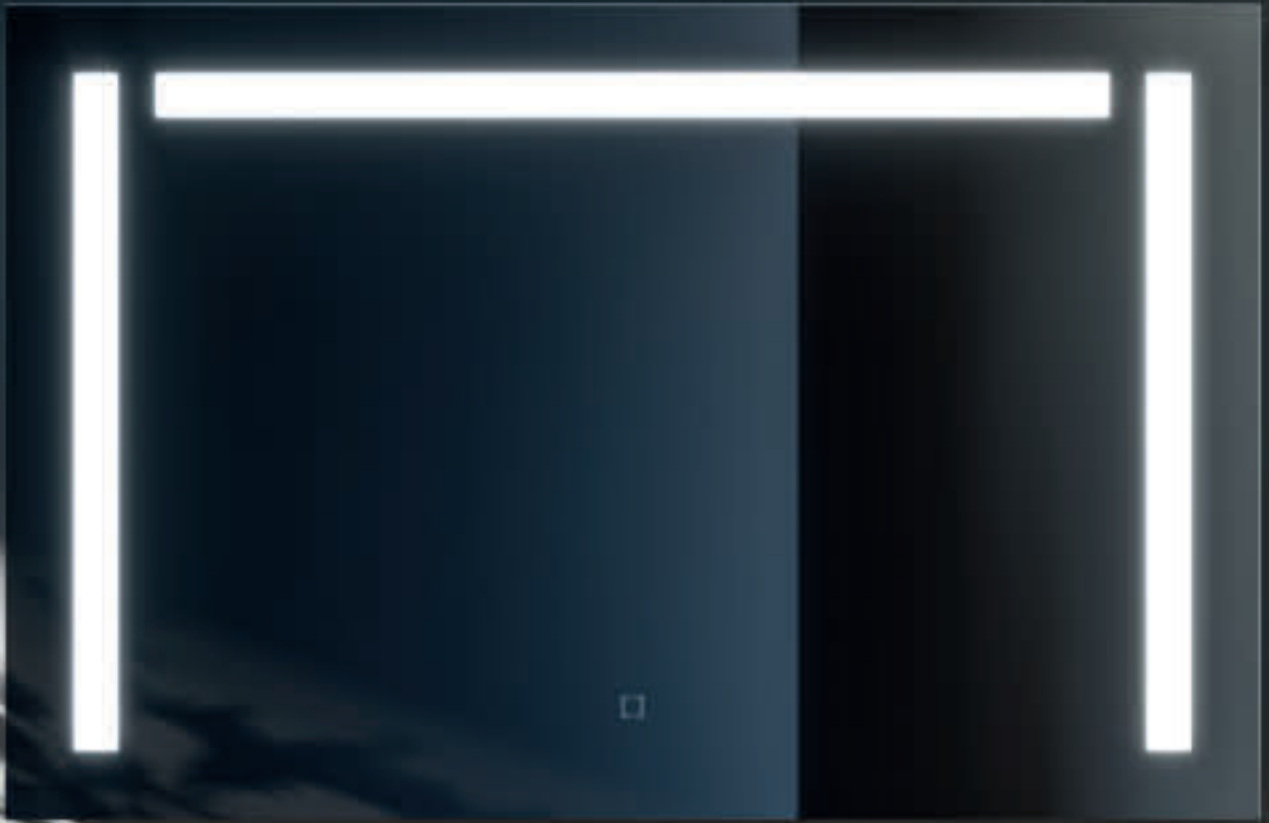

Complicare è facile, semplificare è difficile. Oceano è uno specchio essenziale nel quale la luce prende vita e assume l'intensità, la temperatura e la presenza che desideri semplicemente toccando l'interruttore touch

Complicating is easy, simplifying is difficult. Oceano is an essential mirror in which light comes to life and takes on the intensity and temperature you desire or which lighting bars illuminate by simply touching the sensor switch





Andare all'essenza delle cose. La superficie specchiante si stacca dalla parete e prende vita al passaggio della tua mano con una striscia di luce regolabile nella sua intensità e nella sua temperatura colore.

Going to the essence of things. The mirrored surface detaches from the wall and comes to life at the wave of your hand with a strip of light that can be adjusted in its intensity and color temperature.





3000°K



6000°K







TITAN ROUNDED
Adolini + Simonini



Una sottile striscia luminosa a illuminare la tua immagine. Un bordo in Plexiglas per diffondere la luce nell'ambiente. Due sottili ali reclinabili a donare diverse prospettive al tuo sguardo. Disponibile con angoli retti o arrotondati

A thin strip of light to illuminate your image. A Plexiglas edge to diffuse the light into the environment. Two thin reclining wings to give different perspectives to your gaze. Available with sharp or rounded corners.









TRISTAR GH
R&D Vanità & Casa

specchio contenitore
cabinet mirror



Un capiente contenitore con l'opzione di una mensola a giorno: design e funzionalità in un bagno dove il rigore e l'eleganza vanno di comune accordo, non interrotti ma sottolineati dalla luce che appare come per incanto

A large container with the option of an open shelf: design and functionality in a bathroom where rigor and elegance go hand in hand, not interrupted but emphasized by the light that appears as if by magic



TRISTAR GH
R&D Vanità & Casa

specchio contenitore
cabinet mirror





ZENIT GH
R&D Vanità & Casa

specchio contenitore
cabinet mirror



Eleganza e praticità formano un
connubio esaltato dall'esplosione
di luce che appare magicamente
grazie alla tecnologia GHOST

*Elegance and practicality form
a combination enhanced by the
explosion of light that magically
appears thanks to GHOST
technology*

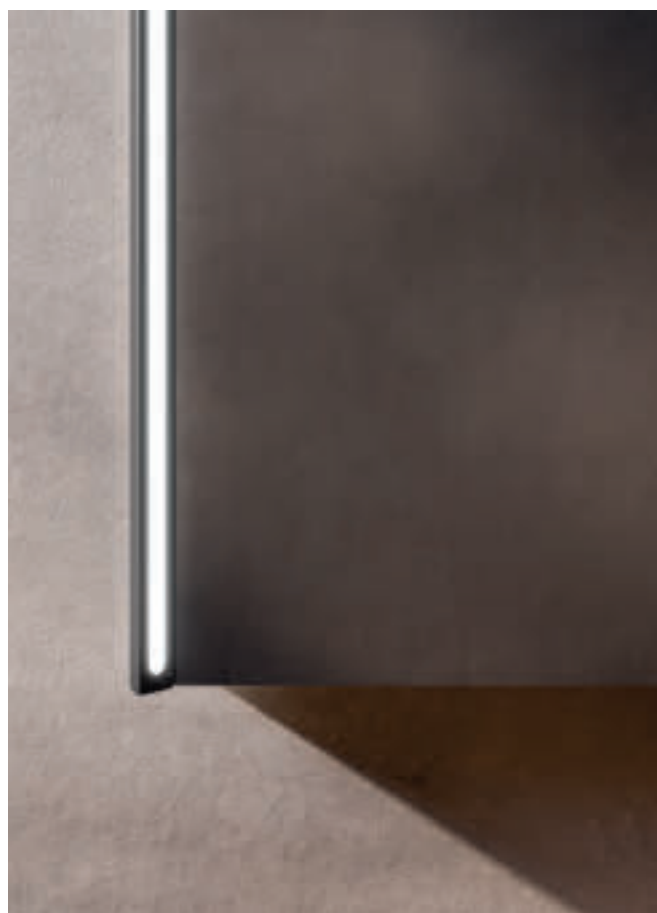
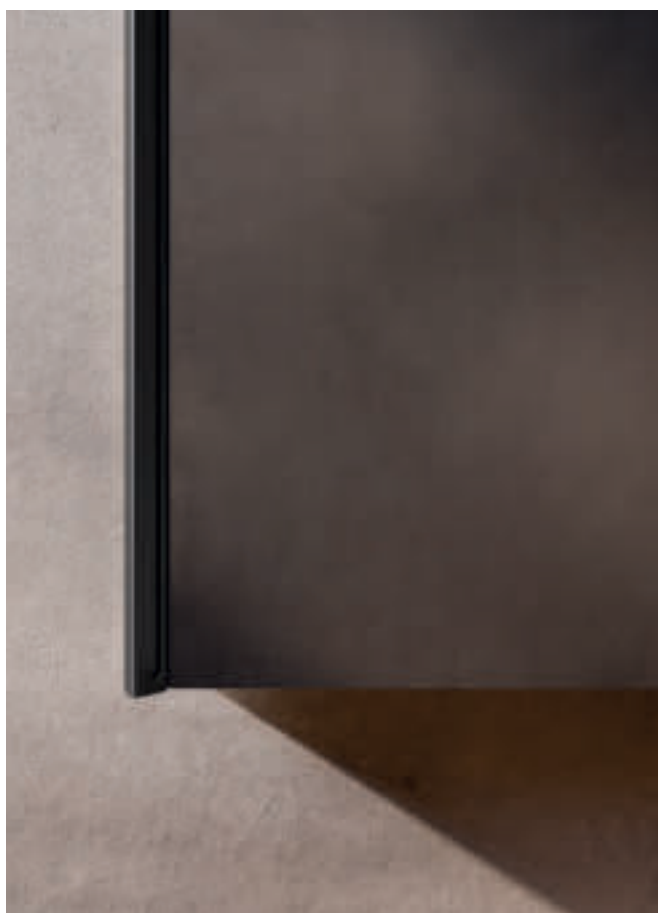

ZENIT GH
R&D Vanità & Casa

specchio contenitore
cabinet mirror

Technical data

HANDY SYSTEM CONSOLE 20-31

CM2 20060 1911 S

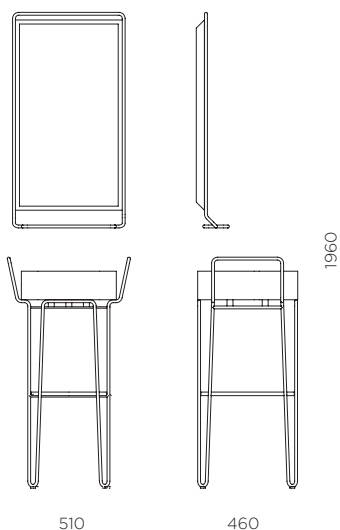

MAGNETICA SYSTEM CONSOLE 32-43

CM1 20078 1901S

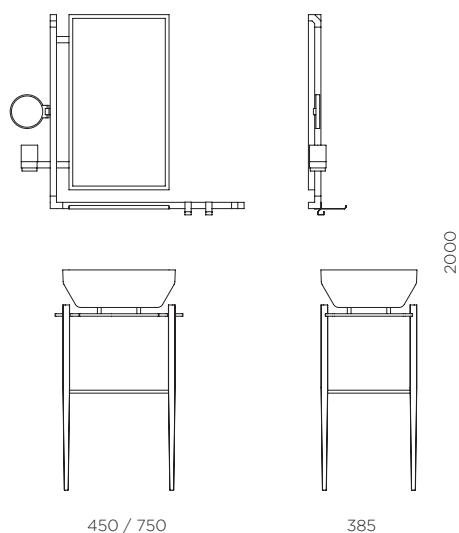

XO MIRROR 44-49

BT 0120 1322 S

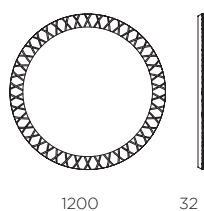

BT 0080 1321 S

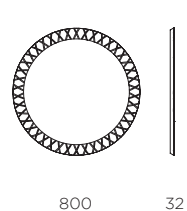

BT 0060 1320 S

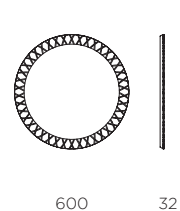

POLLUX GH SHELF MIRROR 54-59

BR 8080 1347 S

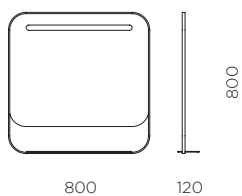

BR 8060 1346 S

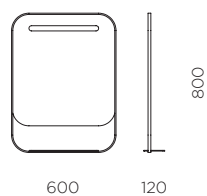

BR 8040 1345 S

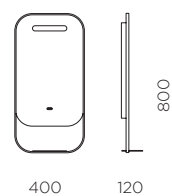

CASTORE GH SHELF MIRROR 60-63

BR 8080 1020 S

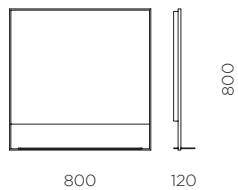

BR 8060 1019 S

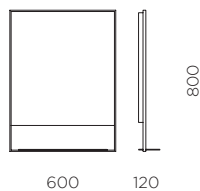

BR 8050 1018 S

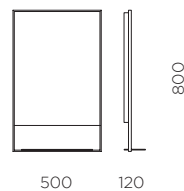

FENICE SHELF MIRROR 64-69

BR 80140 1274 S

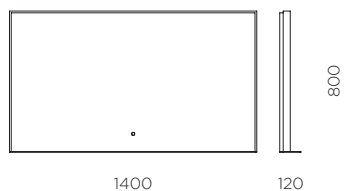

BR 80120 1273 S

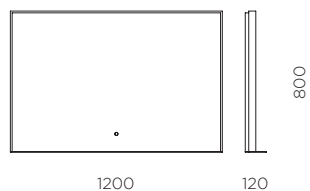

BR 80100 1272 S

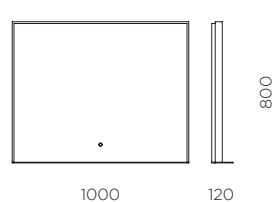

BR 8080 1271 S

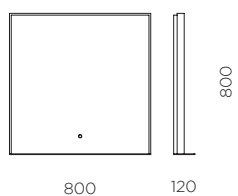

BR 8060 1270 S

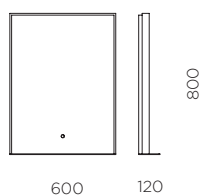

BR 8040 1269 S

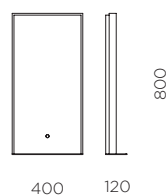

AVIOR MIRROR 70-73

BR 70140 1215 G

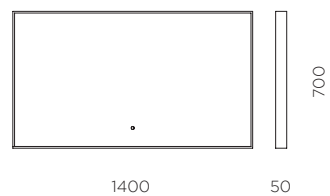

BR 70120 1213 G

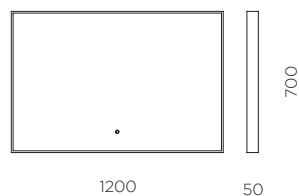

BR 70100 1212 G

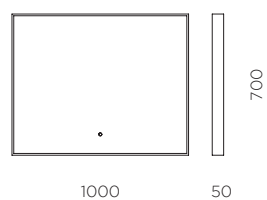

AVIOR MIRROR 70-73

STARBURST MIRROR 74-77

BR 7080 1214 G

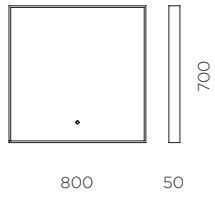

BR 7060 1211 G

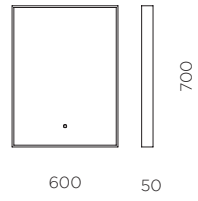

BR 7045 1210 G

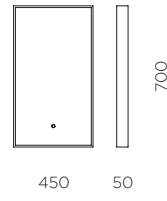

BR 8060 1335 S

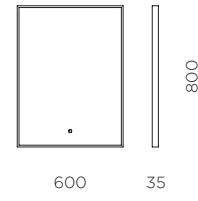

OCEANO MIRROR 78-81

BR 65160 2056 G

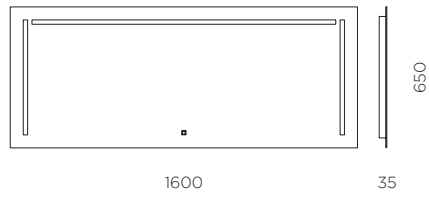

BR 65140 2055 G

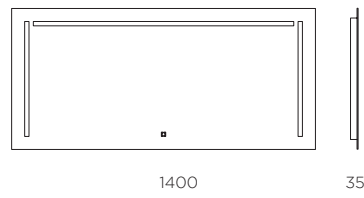

BR 65120 2054 G

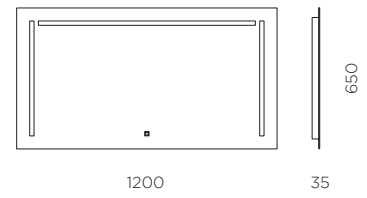

BR 65100 2053 G

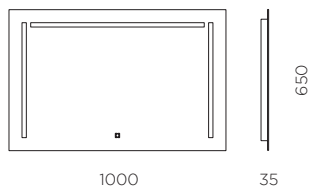

BR 6580 2052 G

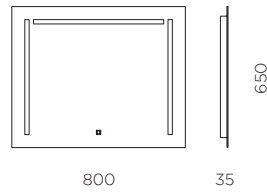

BR 6560 2051 G

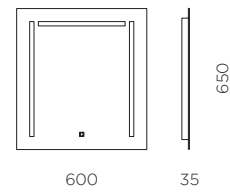

ASTRO MIRROR 82-85

BR 65160 3006 G

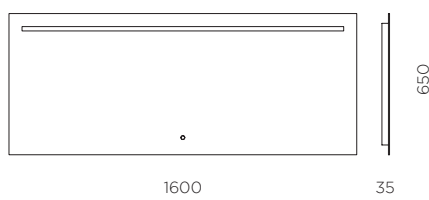

BR 65140 3005 G

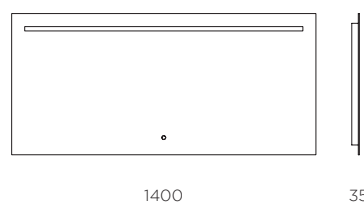

BR 65120 3004 G

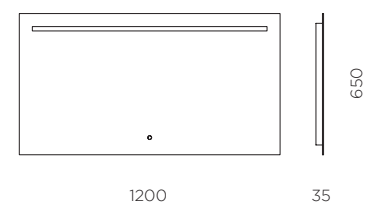

BR 65100 3003 G

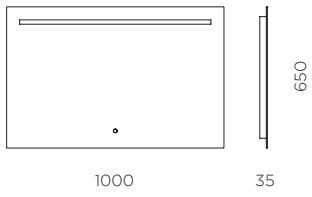

BR 6580 3002 G

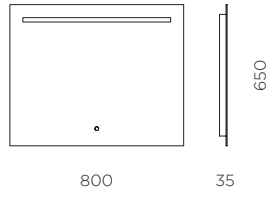

BR 6560 3001 G

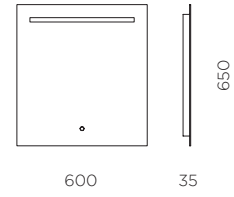

TITAN ROUNDED 86-89

TRISTAR GH CABINET MIRROR 90-93

BR 65120 2217 S

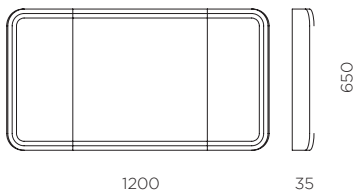

CL2 708013 5022 D

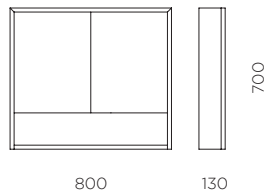

CL2 706013 5021 D

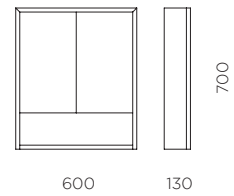

CL2 708013 5025 D

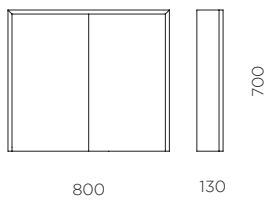

CL2 706013 5024 D

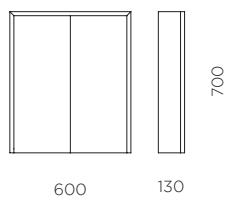

CL1 705013 5023 D

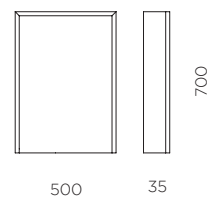

ZENIT GH CABINET MIRROR 94-97

CL2 709014 5108 S

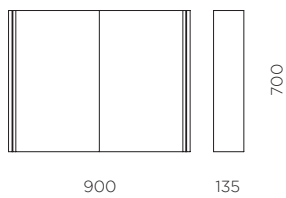

CL2 707014 5107 S

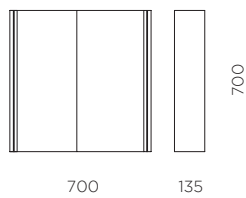

CL1 705014 5106 S

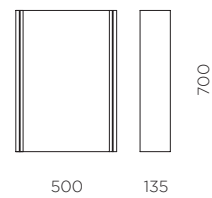

Product description

HANDY

Struttura in metallo nero opaco
Lavabo in solid surface bianco
Mensole in solid surface bianco
Specchio a luce diretta ad alta potenza sui quattro lati con pellicola riflettente
Interruttore touch ON/OFF illuminato
Spessore specchio 5 mm
Pellicola di sicurezza
Funzione antiappannamento
Temperatura colore 6000K
220V, CE, IP44
Black metal structure
White solid surface basin
White solid surface shelf
Direct light mirror with 360° high power LED lighting with reflective film
Illuminated touch ON/OFF sensor switch
5 mm mirror thickness
Safety film backing
Defogger function
LED temperature color 6000K
220V, CE, IP44

MAGNETICA

Struttura e accessori in metallo nero opaco
Lavabo in solid surface bianco
Ripiano in solid surface bianco
Luci integrate sui quattro lati con tecnologia GHOST
Interruttore ON/OFF infrarosso con cambio colore e funzione dimmer
Specchio ingranditore 3X orientabile
Spessore specchio 5 mm
Pellicola di sicurezza
Funzione antiappannamento
Temperatura colore DynamicWhite 3000 - 6000K
220V, CE, IP44
Black metal structure and accessories
White solid surface basin
White solid surface shelf
Four illuminated sides with GHOST technology
Infrared ON/OFF sensor, color change and dimmer function switch
3x magnifying adjustable mirror
5 mm mirror thickness
Safety film backing
Defogger function
DynamicWhite temperature color 3000 - 6000K
220V, CE, IP44

XO

Specchio con sottile bordo in Plexiglas illuminato a LED che diffonde la luce
Luce diretta con tecnologia GHOST
Interruttore infrarosso ON/OFF con cambio colore e funzione dimmer
Spessore specchio 5 mm
Pellicola di sicurezza
Funzione antiappannamento
Temperatura colore DynamicWhite 3000 - 6000K
220V, CE, IP44
Thin Plexiglas edge illuminated by LEDs
Direct light with GHOST technology
Infrared ON/OFF sensor, color change and dimmer function switch
5 mm mirror thickness
Safety film backing
Defogger function
DynamicWhite temperature color 3000 - 6000K, 220V, CE, IP44

POLLUX GH

Luce LED ambientale
Luce diretta con tecnologia GHOST
Interruttore touch illuminato ON/OFF con cambio colore e funzione dimmer
Spessore specchio 5 mm
Pellicola di sicurezza
Struttura metallica colore nero con mensola integrata
Funzione antiappannamento
Temperatura colore DualWhite 3000 o 6000K, 220V, CE, IP44
360° ambient lighting
Direct light with GHOST technology
Illuminated touch ON/OFF sensor, color change and dimmer function switch
5 mm mirror thickness
Safety film backing
Black metal structure inclusive of shelf
Defogger function
DualWhite temperature color 3000 or 6000K, 220V, CE, IP44

CASTORE GH

Luce ambientale a LED 360°
Luce diretta con tecnologia GHOST
Interruttore touch ON/OFF illuminato con cambio colore e funzione dimmer
Spessore specchio 5 mm
Pellicola di sicurezza
Struttura metallica colore nero con mensola integrata
Funzione antiappannamento

Temperatura colore LED TripleWhite 3000- 4000 o 6000K, 220V, CE, IP44
360° ambient lighting
Direct light with GHOST technology
Illuminated ON/OFF touch sensor with color change and dimmer function switch
5 mm mirror thickness
Safety film backing
Metal structure inclusive of shelf
Defogger function
TripleWhite temperature 3000 - 4000 or 6000K, 220V, CE, IP44

FENICE BLACK GH

Telaio in alluminio nero opaco
Luci integrate sui tre lati con tecnologia GHOST
Mensola nella parte inferiore con carica cellulare wireless (vedi codici dedicati)
Interruttore touch illuminato ON/OFF con cambio colore
Spessore specchio 5 mm
Pellicola di sicurezza
Funzione antiappannamento
Temperatura colore DualWhite 4000 o 6000K, 220V, CE, IP44
Black aluminum frame
Three illuminated sides with GHOST technology
Shelf with built-in wireless phone charger (see dedicated mirror codes)
Illuminated touch ON/OFF sensor and color change switch
5 mm mirror thickness
Safety film backing
Defogger function
DualWhite temperature color 4000 or 6000K, 220V, CE, IP44

AVIOR

Telaio in alluminio nero opaco
Luci integrate sui quattro lati con tecnologia GHOST
Interruttore ON/OFF infrarosso con cambio colore e funzione dimmer
Spessore specchio 5 mm
Pellicola di sicurezza
Funzione antiappannamento
Temperatura colore DynamicWhite 3000 - 6000K
Fissaggio orizzontale o verticale
220V, CE, IP44
Aluminum black frame
Four illuminated sides with GHOST

technology
Infrared ON/OFF sensor switch with dimmer
5 mm mirror thickness
Safety film backing
Defogger function
DynamicWhite temperature color 3000 - 6000K
Vertical or horizontal fixing
220V, CE, IP44

STARBURST

Specchio con cornice in Plexiglas illuminato a LED che diffonde la luce
Interruttore touch ON/OFF illuminato con cambio colore
Spessore specchio 5 mm
Pellicola di sicurezza
Funzione antiappannamento
Temperatura colore DualWhite 3000 o 6000K
Montaggio orizzontale o verticale
220V, CE, IP44
Thin Plexiglas frame illuminated by LEDs
Illuminated touch ON/OFF sensor and color change switch
5 mm mirror thickness
Safety film backing
Defogger function
DualWhite temperature color 3000 or 6000K
Vertical or horizontal fixing
220V, CE, IP44

OCEANO

Specchio a luce diretta con tecnologia GHOST
Fasce luminose con accensione differenziata
Interruttore illuminato ON/OFF touch con cambio colore e funzione dimmer
Spessore specchio 5 mm
Pellicola di sicurezza
Funzione antiappannamento
Temperatura colore DualWhite 4000 o 6000K
220V, CE, IP44
Direct light mirror with GHOST technology
Differentiated illumination of light bars
Illuminated touch ON/OFF sensor, color change and dimmer function switch
5 mm mirror thickness
Safety film backing

Defogger function
Dual White temperature color 4000 or 6000K, 220V, CE, IP44

ASTRO

Specchio a luce diretta con tecnologia GHOST
Spessore specchio 5 mm
Interruttore ON/OFF a infrarossi con cambio colore e funzione dimmer
Pellicola di sicurezza
Funzione antiappannamento
Temperatura colore DynamicWhite 3000 - 6000K
220V, CE, IP44.
Direct light mirror with GHOST technology
5 mm mirror thickness
Infrared ON/OFF sensor, color change and dimmer function switch
Safety film backing
Defogger function
DynamicWhite temperature color 3000 - 6000K
220V, CE, IP44.

TITAN ROUNDED

Luce LED ambientale e diretta
Diffusore luce in Plexiglas
Ante laterali pieghevoli con doppio specchio
Interruttore touch ON/OFF illuminato con cambio colore e funzione dimmer
Spessore specchio 5 mm
Pellicola di sicurezza
Funzione antiappannamento
Temperatura colore LED TripleWhite 3000- 4000 o 6000K
220V, CE, IP44
360° ambient light and direct light
Illuminated thin Plexiglas edge
Double mirrored folding sides
Illuminated touch ON/OFF sensor with color change and dimmer function switch
5 mm mirror thickness
Safety film backing
Defogger function
TripleWhite LED temperature color 3000- 4000 or 6000K
220V, CE, IP44

TRISTAR GH

Specchio contenitore

Struttura in alluminio nero opaco
Luce diretta con tecnologia GHOST
Luce LED ambientale sul fondo
Vano a giorno (vedi modelli dedicati)
Ante a doppio specchio con antiappannamento
Cerniere soft-close
Ripiani in vetro temperato regolabili
Interruttore meccanico ON/OFF
Schiena a specchio
Preso rasoio con interruttore luminoso
Preso USB
Temperatura colore LED 4000K
220V, CE, IP44
Cabinet mirror
Black aluminum finish
Direct light with GHOST technology
Ambient light underneath
Open shelf area (see dedicated models)
Double sided mirror door with defogger
Soft-close hinges
Tempered glass adjustable shelves
Mechanical ON/OFF switch
Mirrored back panel
Shaver socket with illuminated switch
USB socket
LED temperature color 4000K
220V, CE, IP44

ZENIT GH

Specchio contenitore
Struttura in alluminio nero con fianchi arrotondati
Luce diretta con tecnologia GHOST
Ante a doppio specchio
Cerniere soft-close
Ripiani in vetro temperato regolabili
Interruttore ON/OFF a infrarosso
Preso rasoio con interruttore luminoso
Temperatura colore LED 4000K
Opzione presa Schuko
220V, CE, IP44
Cabinet mirror
Black aluminum body with rounded sides
Direct light with GHOST technology
Double sided mirror doors
Soft-close hinges
Tempered glass adjustable shelves
Infrared ON/OFF sensor switch
Shaver socket with illuminated switch
LED temperature color 4000K
Option Schuko socket
220V, CE, IP44

\ Direzione artistica
Massimo Farinatti

\ *Art direction*
Massimo Farinatti

\ Graphic design
Massimo Farinatti
Susanna Vallebona

\ *Graphic design*
Massimo Farinatti
Susanna Vallebona

\ Impaginazione
Esseblu

\ *Layout*
Esseblu

\ Rendering
Nudesignstudio
Inthemiddlestudio

\ *Rendering*
Nudesignstudio
Inthemiddlestudio

\ Assistenza fotografica
Post produzione
Riccardo Munarin

\ *Photographic assistance*
Post production
Riccardo Munarin

© Luglio 2021 R&D
Vanità & Casa

© *Luglio 2021 R&D*
Vanità & Casa

\ Stampa
Imoco Spa
Stampato su
UPM Fine
Cartiera UPM

\ *Print*
Imoco Spa
Printed on
UPM Fine
Cartiera UPM



Vanità & Casa s.r.l.
Via Cima Manera, 11
33081 Aviano (PN) - Italy
T +39 0434 786049
info@vanitacasa.it
www.vanitacasa.it